

## User Manual

# LAQUAtwin pH Meters

Product Code: PQ0001, PQ0002, PQ0003



## USER Manual – LAQUAtwin pH Meters

### Part Names

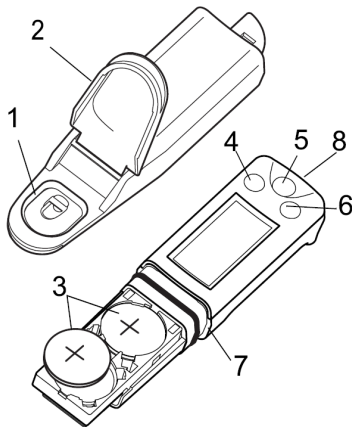

- Measurement cell
- Protection cover
- Lithium batteries
- MEAS switch
- ON/OFF switch
- CAL switch
- Waterproof gasket
- Strap eyelet

**Note:** Press the switches 0.5 seconds or more unless otherwise specified.

### Initial Setup

#### Attaching the sensor:

1. Power OFF the meter.
2. Confirm that the waterproofing gasket is clean and undamaged.
3. Slide the sensor onto the meter so that catch "A" on the back of the meter fits into hole "a" on the sensor tongue as shown.

**Note:** Be careful not to twist the waterproof gasket.

#### Detaching the sensor:

1. Power OFF the meter.
2. Lift the sensor tongue tip and slide the sensor a little away from the meter.
3. Pull out the sensor all the way from the meter.

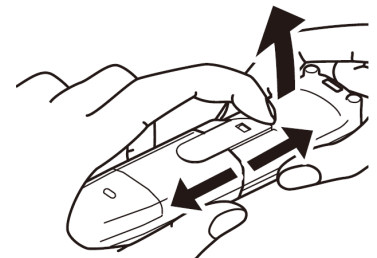
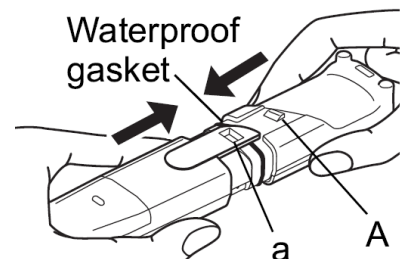

#### Inserting the batteries:

1. Power OFF the meter.
2. Slide both batteries into the battery case as shown.
3. Be sure to use two Battery CR2032 batteries and put Battery clip them with the plus sides (+) upwards.

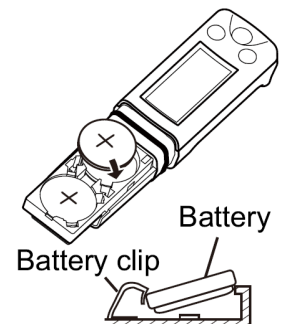

### Removing the batteries:

1. Power OFF the meter.
2. Use a ball-point pen or other tool to pry the batteries out from the clips as shown.

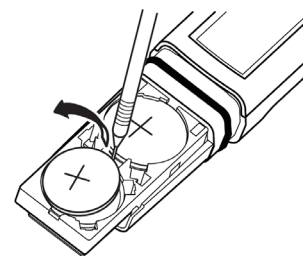

### Electrode conditioning:

**Notes:** Before using the sensor for the first time or after several days of disuse, perform electrode conditioning. Perform calibration after electrode conditioning.

1. Place some drops of the pH 7 standard solution on the flat sensor.
2. Wait a few hours before use. There is no need to switch the meter ON.
3. Clean the flat sensor with running water.

## Basic Operation

### Power ON:

1. Press and hold the ON/ OFF switch. The power is switched ON, and the meter model number is displayed on the LCD.

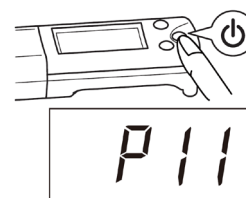

### Power OFF:

1. Press and hold the ON/OFF switch. The power is switched OFF.

## Calibration

Calibration is required before measurement. Use standard solution within the measurement range in the specifications.



**Note:** Calibration values are saved even if the meter is switched OFF. Calibration value is rewritten if calibration is repeated using the same standard solution. Select the pH standard solutions close to the pH value of sample when the sample is known. Perform three-point calibration using pH 4.01, pH 7.00 (6.86), and pH 10 (9.18) standard solutions when the sample is unknown.

### Calibration points:

The number of calibration points is dependent on the meter model. Visit [portal.klipspringer.com/laquatwin-pocket-meters/c-1243.html](https://portal.klipspringer.com/laquatwin-pocket-meters/c-1243.html)

### Multi-point calibration:

1. Select the standard from USA or NIST. (Refer to "Buffer standard change") USA is selected by the default.
2. Open the light shield cover and place some drops of the standard solution on the flat sensor taking care to cover the entire flat sensor. Rinsing the sensor with the standard solution beforehand will provide a more accurate calibration as it will reduce sample crossover contamination.

3. **Close the light shield cover and press the CAL switch.**  and 😊 blink, and the calibration value is displayed: After the calibration is complete,  and 😊 stop blinking and the measured value is displayed. The calibration value at 25°C is displayed for 1s and the display returns to the measurement mode automatically.

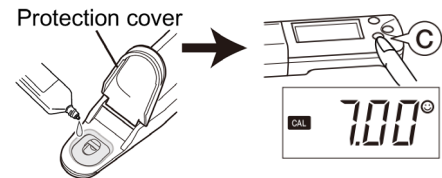

4. **Open the light shield cover and remove the standard solution.** Then remove moisture on the sensor by gently dabbing with a soft tissue. This completes the 1st point calibration.
5. **To perform 2nd point calibration, repeat steps 2. to 4**

### Calibration error:

If  blinks and Er4 (error display) appears, the calibration has failed. Perform electrode conditioning.

Check that the correct standard solution is used, and repeat calibration after cleaning the sensor. If the calibration repeatedly fails when using the correct standard solution(s), the sensor may have deteriorated. Replace the sensor with new one.

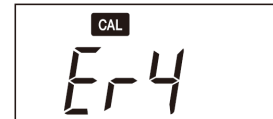

## Measurement

### Sample setting:

1. Open the light shield cover and put some drops of sample on the flat sensor to cover the entire flat sensor.
2. Close the light shield cover.

### Measurement mode:

The auto stable (AS) mode and the auto hold (AH) mode can be selected. Refer to "● Measurement mode change" (page 4) for the operation to set the measurement mode.

#### Auto stable (AS) mode

This is the default setting. 😊 appears when the measured value meets the stability criteria. If the value changes, 😊 disappears.

1. **Confirm that the meter is in the measurement mode and place a sample on the sensor.** When the read value meets the stability criteria, 😊 appears and the reading is locked.
2. **Document the displayed value when 😊 appears.** If the read value does not meet the stability criteria, 😊 disappears and the reading changes with time.



#### Auto hold (AH) mode

😊 appears when the measured value meets the stability criteria. The reading then locks and will not change until the MEAS switch is pressed for the next measurement.

1. **Confirm that the meter is in the measurement mode and place a sample on the sensor.**

2. **Press the MEAS switch.** The auto hold function is activated. **MEAS** blinks until the measured value has stabilized. When the measured value is stable, stops blinking and the displayed value is locked with and ☺ displayed simultaneously.



3. **Document the displayed value.**

4. **Press the MEAS switch.** The auto hold function is deactivated and ☺ disappears. Be sure to perform this step before starting the next measurement. Or, you may mistake the displayed hold value for the next measured value.

**Note:** If a measured value is out of the specified measurement range, "Or" is displayed for upper range and "Ur" is displayed for under range. Ambient air may cause the measured values to fluctuate. To reduce environmental interference, close the protection cover. When you have a problem with the calibration measurement, refer to frequently asked questions.

### Measurement display change:

The display mode switches as follows by pressing the MEAS switch in the AS mode.

PQ0001 and PQ0002:

- Between pH and voltage alternately

PQ0003:

- Among pH, voltage and temperature

## Maintenance

### Storage:

1. Clean the sensor with tap water.
2. Dab gently with soft tissue or cloth to remove moisture on the sensor and meter.  
**Note:** Especially be sure to treat the sensor gently to prevent damaging it.
3. Close the light shield cover and slide cap before storing the meter.

### Temperature sensor adjustment:

Temperature sensor adjustment is available on the PQ0003. To perform accurate measurement with correction for temperature effects, follow the steps below. Normally this is not necessary.

1. **Ready a reference thermometer, and allow the meter and reference thermometer to reach to room temperature.**
2. **Set the display mode to temperature referring to " Measurement display change" (page 2).**
3. **Press the CAL switch.** The meter displays the setting screen for target temperature.
4. **Press the MEAS switch to adjust the displayed temperature on the meter to match the temperature indicated by the reference thermometer.** Pressing the MEAS switch increases the displayed temperature. After the displayed temperature reaches 400C, it returns to 50C.
5. **Press the CAL switch again to apply the displayed value to the adjustment.** The adjustment starts. The adjusted value blinks with **CAL** and °C displayed. After the adjustment is complete, the adjusted value stops blinking with MEAS and °C displayed. If Er4 (error display) appears, the adjustment has failed. Retry the above steps increasing the time spent on the step 1. If the adjustment repeatedly fails, the sensor may have deteriorated. Replace the sensor with new one.

### Initializing calibration data:

Initialize calibration in the following cases:

- To delete the calibration data
- If the number of points for the last calibration is uncertain.

- After the sensor is replaced.
- 1. **Press and hold the CAL and ON/OFF switches for over 3 seconds when the meter is switched OFF to initialize calibration.** After a moment of all segment indication, the software version is displayed And then , the display changes as shown right.
- 2. **Press the CAL switch.** All calibration data is reset. When the initialization of calibration data is complete, End appears. The meter automatically switches OFF.



### Initializing the settings:

All setup choices are erased. The meter is reset to the factory default values.

1. **Press and hold the MEAS, CAL and ON/OFF switches for over 3 seconds when the meter is switched OFF to enter the initialization.** After a moment of all segment indication, the software version is displayed. And then, the display changes as shown right.
2. **Press the CAL switch.** All calibration data is reset. When the initialization of settings is complete, End appears. The meter automatically switches OFF.



## Appendix

### FAQ

How can I check the sensor's condition?

- Perform 2-point calibration. If calibration error occurs, the sensor has deteriorated. Replace the sensor.

Can I measure high or low temperature samples?

- This meter cannot measure a sample with temperatures outside the meter's operating temperature range (5°C to 40°C). The difference between the sample temperature and ambient temperature increases the measurement error. Perform measurement after the sample reaches the ambient temperature.

The measured value does not change after changing the sample.

- If ☺ lights steadily in AH mode, the measured value is locked. Press the MEAS switch to unlock the value. If the value does not change after unlocking, the sensor may be damaged. Replace the sensor.

"Or" or "Ur" blinks in value measurement.

- The measured value may be out of the specified measurement range. Measure a standard solution to check, and if "Or" or "Ur" still blinks, replace the sensor.

°C blinks during measurement.

- The measured temperature is not within the specified operating temperature (50C to 400C). If the ambient temperature is within the specified range and oc blinks, replace the sensor.

The meter does not power ON.

- Check that the batteries are inserted properly. If the battery voltage is low, replace them both with new ones at the same time.

Er4 is displayed during the calibration.

- Please note that if you press the CAL switch in mV or temperature display mode, Er4 is displayed. This is because there is no calibration facility available for these modes.

Er1 is displayed soon power ON.

- The internal IC in the meter may be defective. Perform meter initialization. If Er1 is still displayed after the initialization, the internal IC in the meter is defective. Replace the meter with a new one (the meter cannot be repaired).

Er2 is displayed right after power ON.

- The internal IC in the meter is defective. Replace the meter with a new one (the meter cannot be repaired).

Er3 is displayed right after power ON.

- The internal IC in the meter is defective. Replace the meter with a new one (the meter cannot be repaired).

## Setup Mode

The setup mode allows the user to customize the meter to his specific needs. To enter the setup mode, press and hold the MEAS and ON/OFF switches for over 3 seconds when the meter is switched OFF. All the LCD segments appear and then the meter enters the setup mode.

**Note:** To have the changes apply, you need to go through the entire steps from "Setup mode entry" to "Setup completion" shown below. To leave a setting as it is, just press CAL switch in the setting. To exit the setup mode with no change of settings, press the ON/OFF switch earlier than pressing CAL switch in the last step but one, or the "Backlight setting" step.

### Setup mode entry:

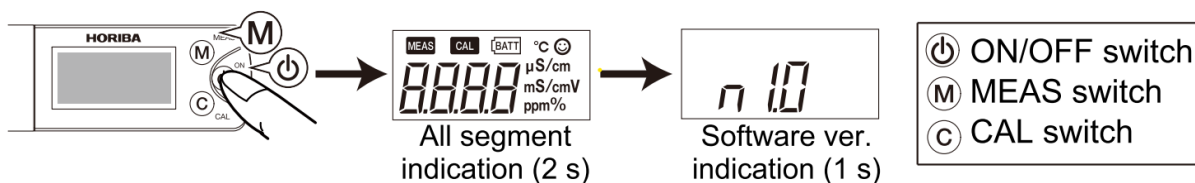

### Buffer standard change:

The standards of pH buffer can be changed.

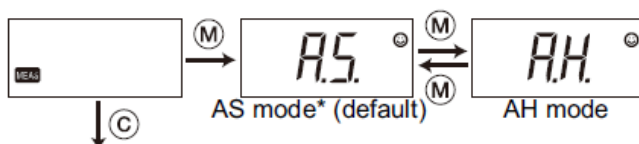

### Measurement mode change

The measurement mode can be switched.

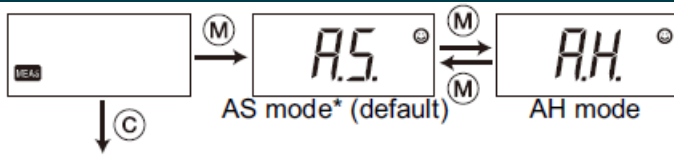

\* Measurement display change is available in the AS mode. Refer to "Measurement display change" (page 2).

**Backlight setting**

The backlight can be switched to ON or OFF.

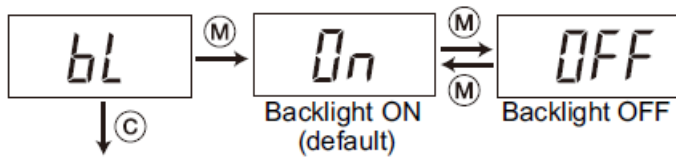

**Setup completion**

